

1、 MAXIMUM RATINGS:

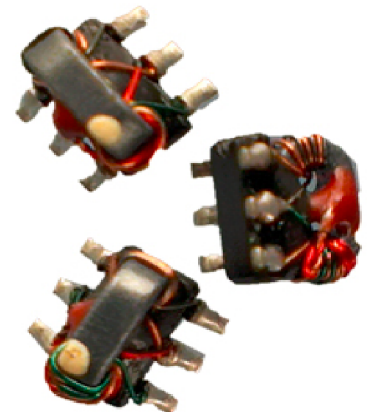

- ◆ 2 Way-0° Power Splitter/Combiner
- ◆ 75Ω Characteristic Impedance
- ◆ Frequency: 5 to 1000 MHz
- ◆ Power Input(as a splitter): 0.50W Max
- ◆ Insertion loss: 4.10dB Max; Isolation: 16.0dB Min
- ◆ Operating temperature range: -40 °C to +85 °C
- ◆ Storage temperature range: -55 °C to +100 °C

2、 DIMENSION DIAGRAM (Unit:mm) :

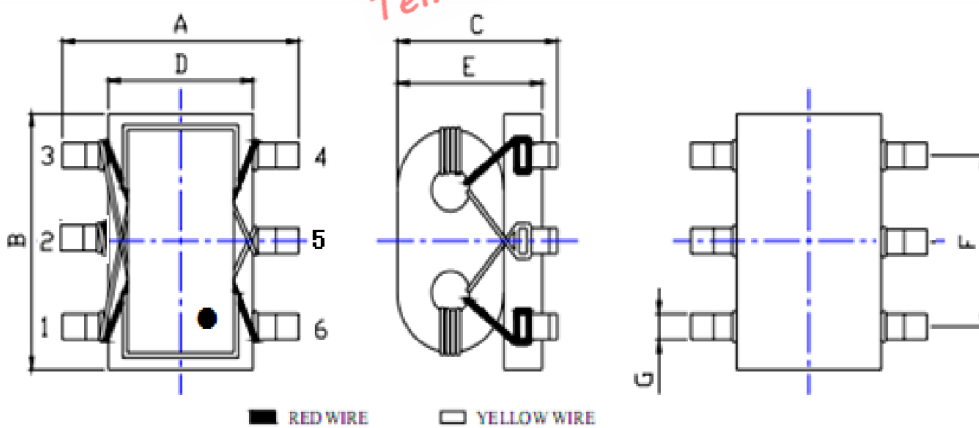

A: 4.00±0.20 B: 3.80±0.20 C: 3.50 Max D: 2.80±0.20 E: 3.00±0.20 F: 2.54±0.05 G: 0.50 Ref

3、 ELECTRICAL STRUCTURE:

4、 RECOMMENDED LAYOUT:

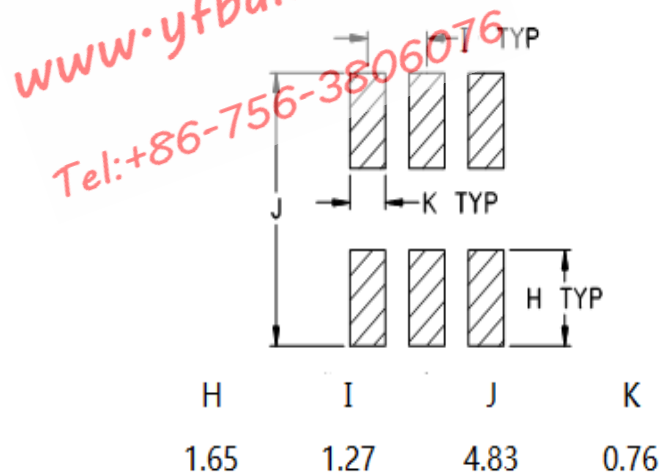
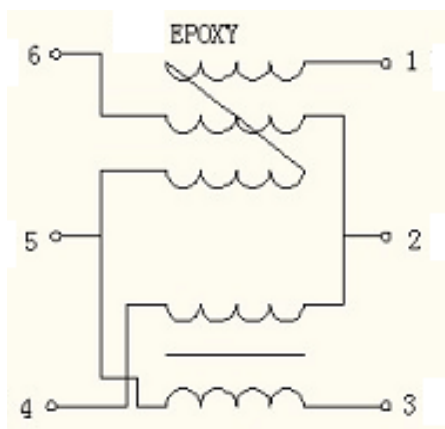

DRAW BY

yang lin

CHECKED BY

ye yong jun

APPROVED BY

deng gao

5、APPLICATION CIRCUIT:

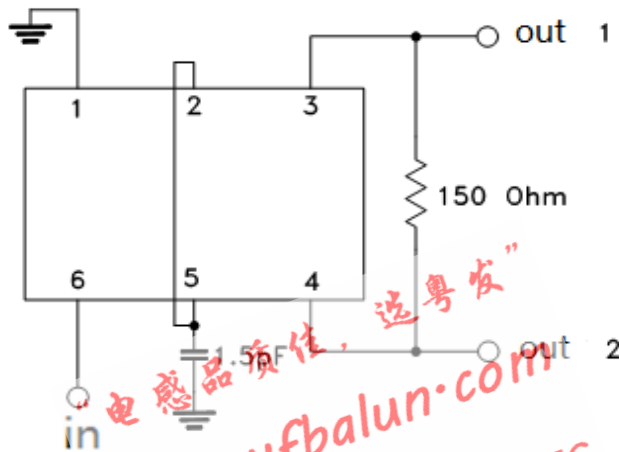

6、INSERTION LOSS TEST CURVE:

Output 1 Insertion Loss:

Output 2 Insertion Loss:

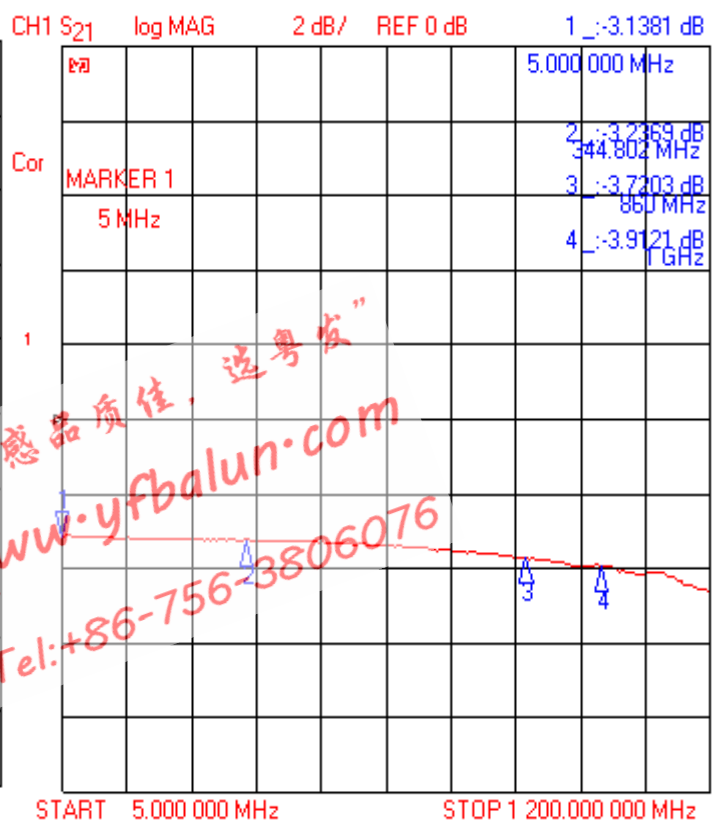
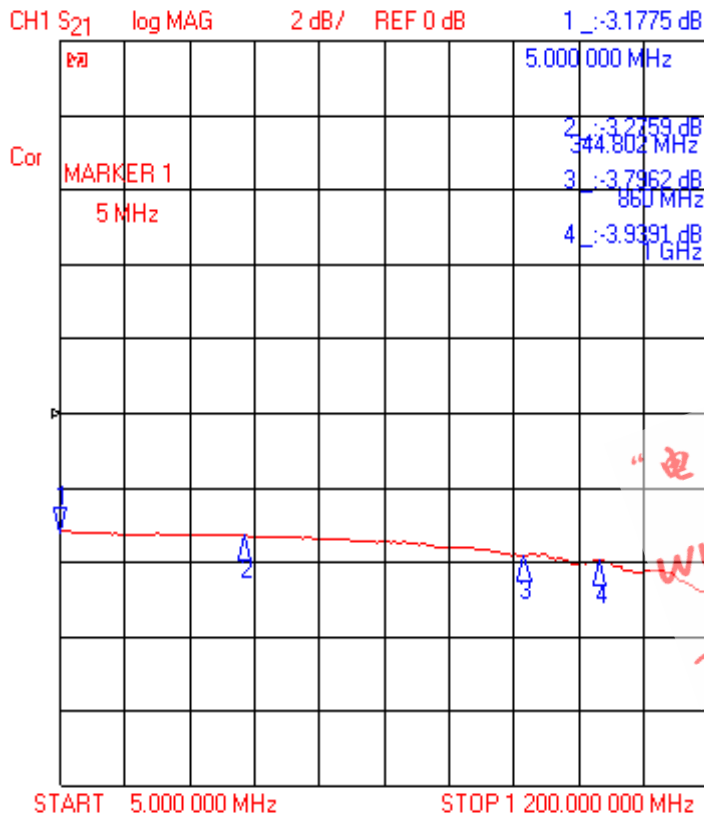

DRAW BY

yang lin

CHECKED BY

ye yong jun

APPROVED BY

deng gao

7、RETURN LOSS TEST CURVE:



Input Return Loss:

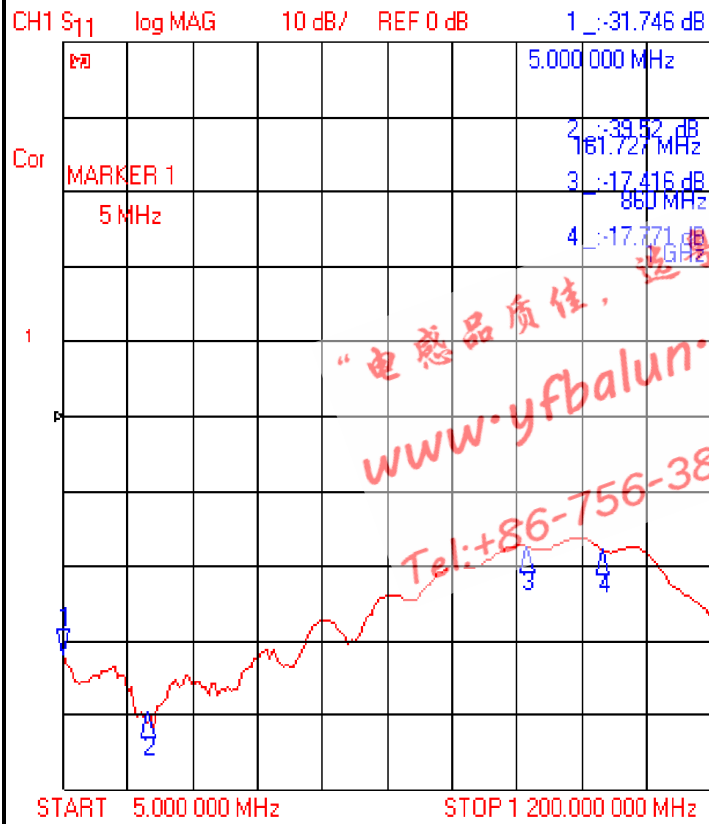

Output 1 Return Loss:

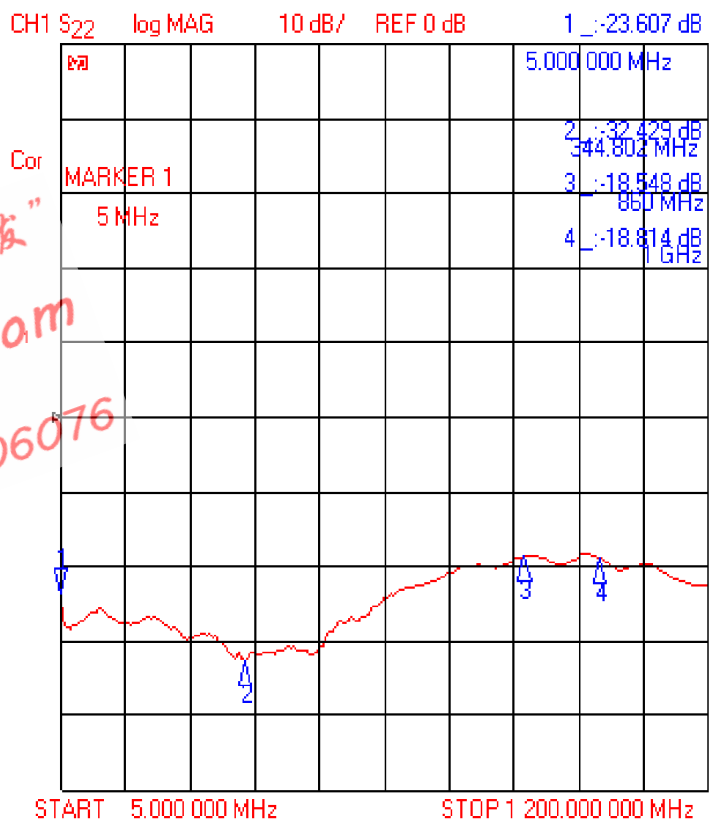

Output 2 Return Loss:

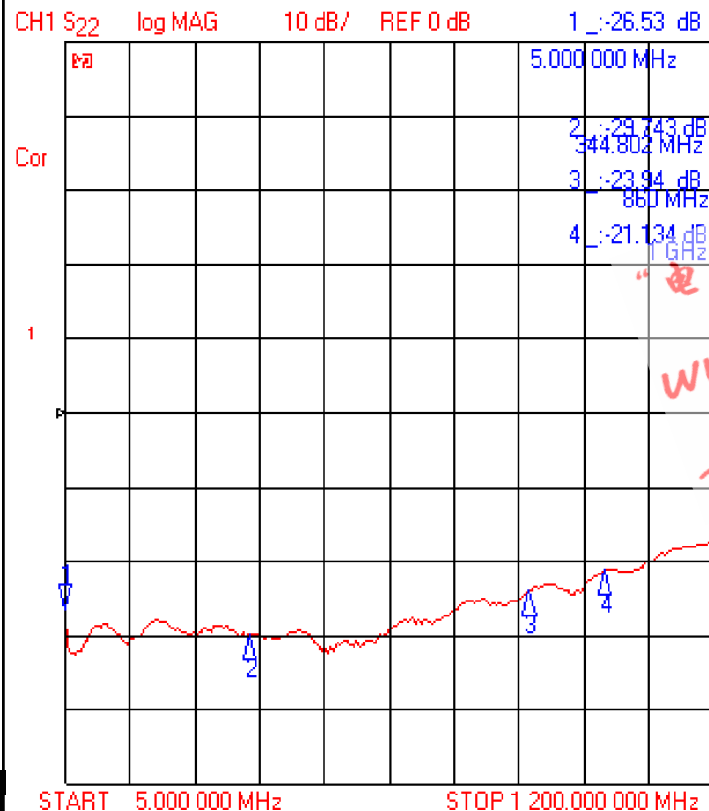

Isolation:

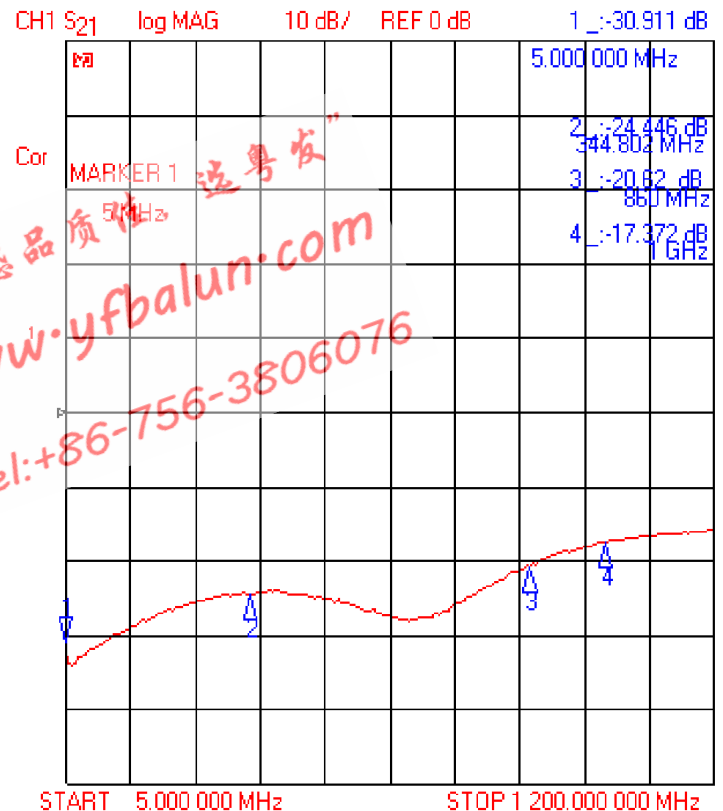

DRAW BY

yang lin

CHECKED BY

ye yong jun

APPROVED BY

deng gao

8、RECOMMENDED SOLDERING TEMPERATURE GRAPH:

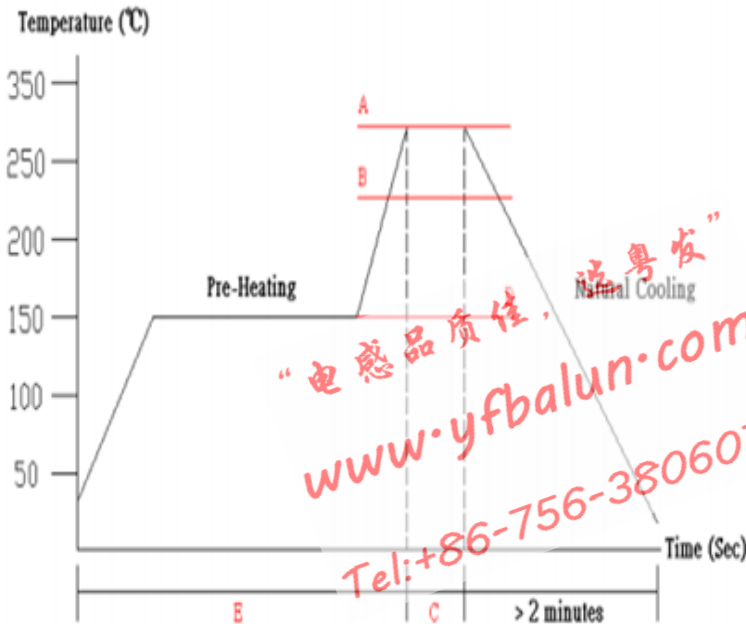

Testing Point :	
Welding joint	
Component surface	
A	260°C
B	230°C
C	10 Sec
D	150°C
E	60~240 Sec

9、PACKAGING DIMENSION FOR CARRIER TAPE&REEL(UNIT:mm)

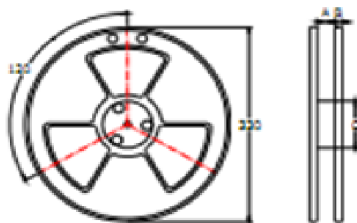
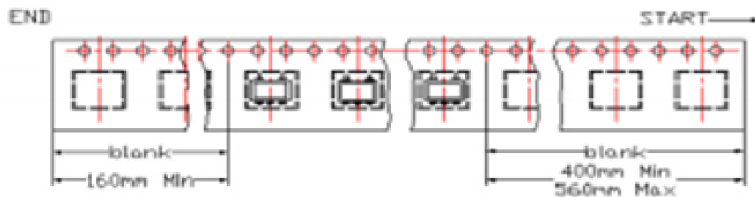

SPEC	8	12	16	24	32	44	56	72
DIM A±0.1	8.5	12.5	16.5	24.5	32.5	44.5	56.5	72.5
DIM B±0.1	2.3	2.3	2.3	2.3	2.3	2.3	2.3	2.3
DIM C±0.1	100	100	100	100	100	100	100	100

“电感品质佳，选粤发”

www.yfbalun.com

Tel:+86-756-3806076

QUANTITY

2000PCS/Reel

15 reel/Big carton/60000pcs

DRAW BY

yang lin

CHECKED BY

ye yong jun

APPROVED BY

deng gao